

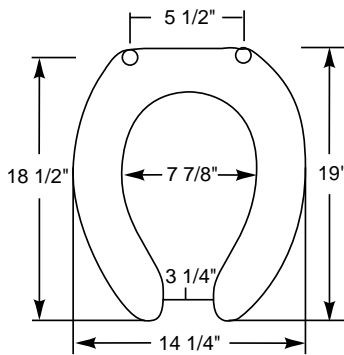

M E D I C - A I D [®] S E A T S

3L2155

Seats shall be No. 3L2155 as manufactured by Bemis Manufacturing Co. to allow an additional 3" of height above the rim of the bowl. Seats shall contain DuraGuard[®], an antimicrobial agent. Seats shall be heavy weight and injection molded of solid plastic. Seats shall be open front less cover for elongated bowl and feature large molded-in bumpers. External check hinge to feature 300 Series stainless steel posts that stop seat 11 degrees beyond vertical. Uses 300 Series stainless steel hardware. Color to be white.



Ring thickness is 13/16"
Ring thickness including the bumper is 3"
Height of the seat is 4-1/4"